

New Economical Series Added

CS1W-P□□□□

Process Analog I/O Units

Ideal for Analog Signal Monitoring and Data Logging Systems.

Meeting Constantly Rising Safety Standards such as HACCP, GMP, and ISO.
Innovative PLC-based Solutions to Analog Monitoring and Control Requirements.



***Innovation
in the Solution Age***

OMRON INDUSTRIAL AUTOMATION

**SMARTPROCESS
CONTROL**

Do You Want to Construct an Analog Data Monitoring/Logging System Easily and Quickly?

The Process Analog I/O Unit Will Let You Do Exactly That.

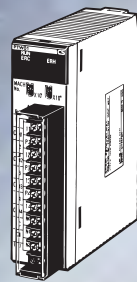

CS1W-PTS11/51/55
Isolated-type
Thermocouple Input Unit

CS1W-PTS12/52/56
Isolated-type
Resistance Thermometer
Input Unit



Thermocouple,
Resistance Thermometer

Temperature

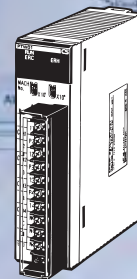

CS1W-PTW01
Isolated-type
2-Wire Transmitter
Input Unit



4 to 20-mA
2-Wire Pressure Sensor

Pressure

Process Analog I/O Unit

- Isolation prevents interference between inputs
- High-speed conversion (10 ms max. speed)
- Equipped with various arithmetic operation functions
- Max. system size: Up to 80 Units
- Windows-based software simplifies settings



Alarm



Logging



Remote



Trend



Visual

PLC Reporter

- Allows PLC data to be uploaded to an Excel file in a personal computer with no programming necessary.

Ethernet 100 Mbps



CS1

SYSMAC CS1

- Industry's fastest* instruction execution. *As of July 2003.
- Seamless networking
Seamless communications between Ethernet, Controller Link, DeviceNet, and other networks.
- Compact flash card slot provided as standard equipment.
Logging and other data can be saved onto compact flash card, converted to CSV files, and analyzed in Excel.

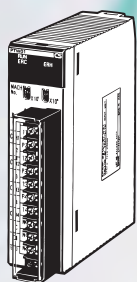

CS1W-PDC11/55
Isolated-type
DC Input Unit

4 to 20-mA
Concentration Sensor

Concentration

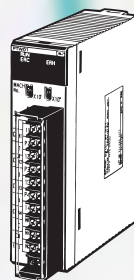

CS1W-PPS01
Isolated-type
Pulse Input Unit

Pulse Output-type Flow Meter

Flow rate

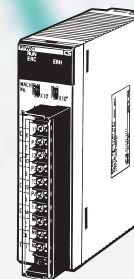

CS1W-PDC11/55
Isolated-type
DC Input Unit

4 to 20-mA Sensor

Fluid level

Solve Customer Problems with Process Analog I/O Units

Application 1

Reducing Cost and Saving Space

External devices such as converters, isolators, and power supplies are unnecessary. Up to 640 words of multipoint data logging, and data acquisition with a cycle time as short as 0.01 s in an isolated-type Unit.

A Process Analog I/O Unit, which can receive direct sensor inputs, is mounted to a SYSMAC CS-series PLC. In general, this configuration can reduce costs by 1/2 and reduce the required space by 1/3 compared to conventional systems.

New

- It is not necessary to connect external isolators because the Process Analog I/O Unit's inputs are isolated.
- An external power supply and distributor are also unnecessary when 2-wire Transmitter Input Units are being used.

- PLC acquisition of temperature and analog data at speeds up to 10 ms^{*1} and 16-bit resolution. Meets a wide range of application needs, from routine data measurements to laboratory requirements.
- Energy-saving^{*2} high-resolution type suitable for multipoint logging applications.

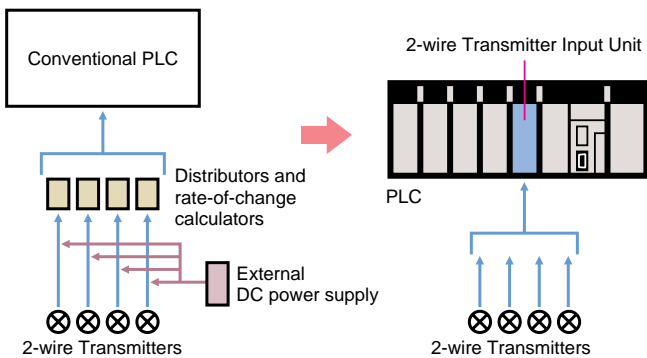

Example: CS1W-PTS01-V1

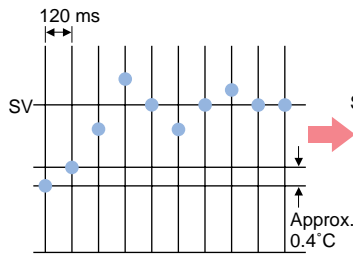

Example: CS1W-PTS11

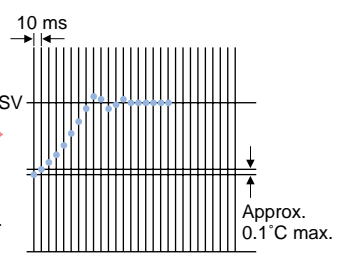

*1 : When using only two of the four points.

*2 : A maximum of 10 Units can be used on one backplane using a CS1W-PA209R Unit. Power consumption of the CS1W-PTS12 is approx. 48 % less than the previous CS1W-PTS02.

Application 2

Reducing Engineering Costs

Functionality is already built into the Unit, so programming is easy. Furthermore, settings are easy to make with the Process Analog I/O Unit Support Software.

- Example: Ladder Programming for High/Low Alarm with Hysteresis (OMRON)

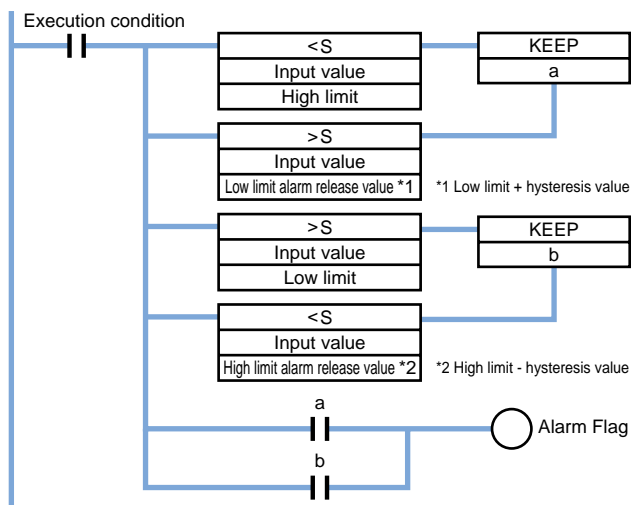

Process Analog I/O Unit Support Software

Settings for Process Analog I/O Units and Analog I/O Units can be performed using Windows-based software. This software allows various parameter types to be input in tabular or interactive form, and allows settings to be stored in files. It also enables operation simulation and simple monitoring.

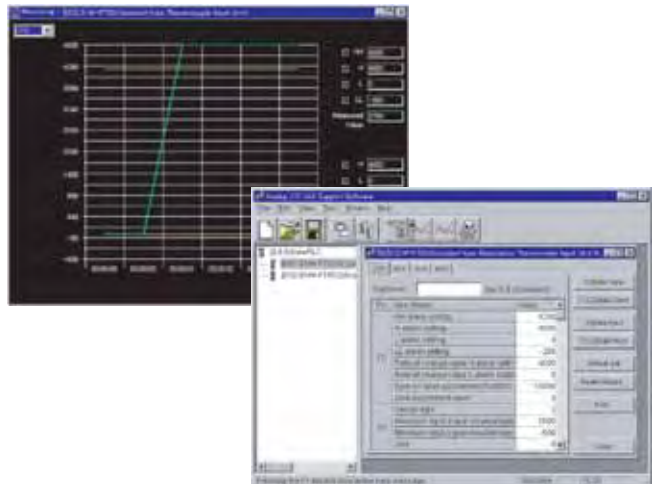

Process Analog I/O Unit

The number of steps is reduced by one-half to one-third!

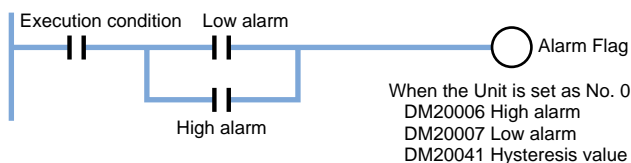

Application 3

**Constructing a High-reliability Monitoring System
Inputs are Isolated**

Use an Isolated-type Input Unit in the data logging system if the monitoring application requires very accurate data collection. These models provide protection against data inaccuracies due to external noise, grounding problems, or disconnection.

- Preventing Effects from Noise

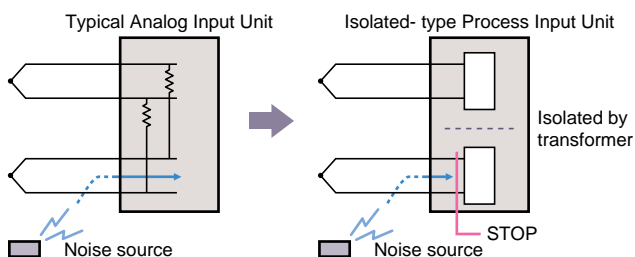

- Preventing Interference between Inputs (Preventing Undesired Circuit Paths)

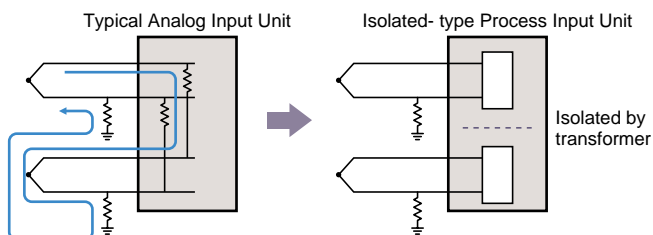

Application 4

**Using Inputs from Sensors in the Existing System
A Wide Range of Models for Various Signals**

Process Analog I/O Units support various types of analog signal, such as thermocouple input, resistance thermometer input (Pt100, JPt100, Ni508.4 Ω), 4 to 20-mA current input, 1 to 5-V voltage input, ±1-mA and 0 to 1-mA input for power transducers, and 0 to 100-mV DC input.

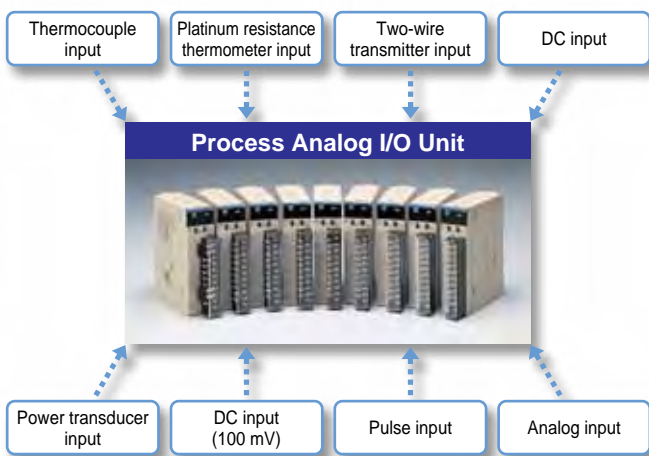

Application 5

**Allowing for System Expansion
Add a Loop Control Board* for Even Greater Flexibility**

When expanding the controlled system, use a Loop Control Board that is supported by the CS-series PLCs. With a Loop Control Board, function blocks can be combined freely to provide the flexibility of special control systems, such as cascade control, feed-forward control, and dead time compensation control.

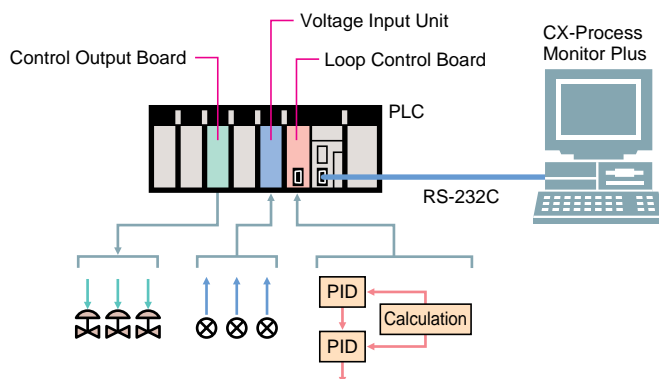

*Refer to catalog number P051 for details on the Loop Control Board.

Application 6

**Providing Remote Maintenance Capability
Easy Remote Monitoring when an OMRON PLC Is Used**

If the control system is built upon a SYSMAC CS-series PLC, remote maintenance can be performed easily as shown below.

- Data can be monitored from a remote personal computer by connecting to the PLC's host link (RS-232C) port through a modem (via a telephone circuit).

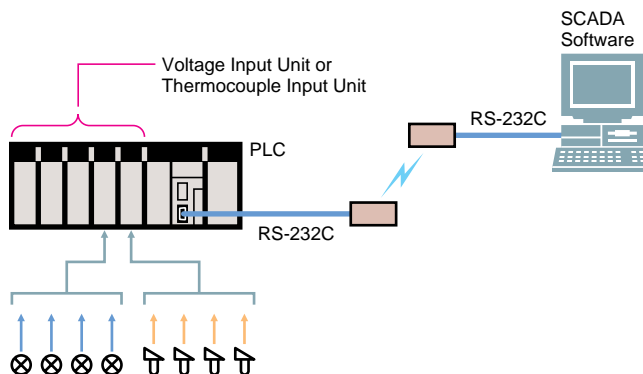

Applications

EXAMPLE 1 Monitoring the Weight of a Blending Tank

Raw materials A and B are blended and the blended liquid is supplied at a fixed flowrate. The weight signal (4 to 20 mA) from a load signal is input to a CS1W- PDC11 Isolated-type Analog Input Unit. The CS1W- PDC11 has a built-in rate-of-change alarm function, so it is possible to monitor the rate at which the weight is changing without any programming. It is even possible to send a message to a particular e-mail address when an alarm is detected.

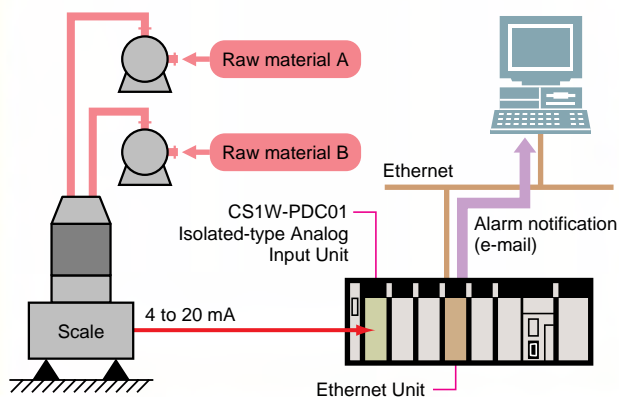

EXAMPLE 3 Measuring Data from Test Equipment

The motor is operated by an inverter, and the desired measurements such as temperature, pressure, flowrate, and speed are taken at each point. A highly reliable monitoring system can be constructed by using Isolated-type I/O Units to provide protection against data inaccuracies due to external noise, grounding problems, or disconnection.

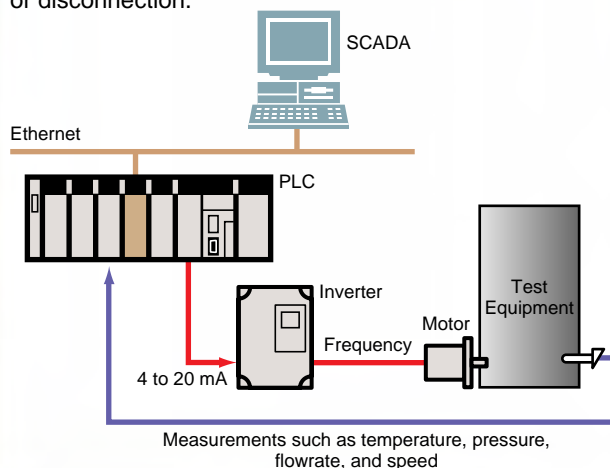

EXAMPLE 2 Telemetry and Telecontrol

There are a wide range of CS-series I/O Units available besides the Process Analog I/O Units, so a complete system can be configured around the PLC. It is possible to transfer large quantities of data, so combine the number of Units required based on the scale of the system. An FA Modem that mounts directly to a DIN Track can be used.

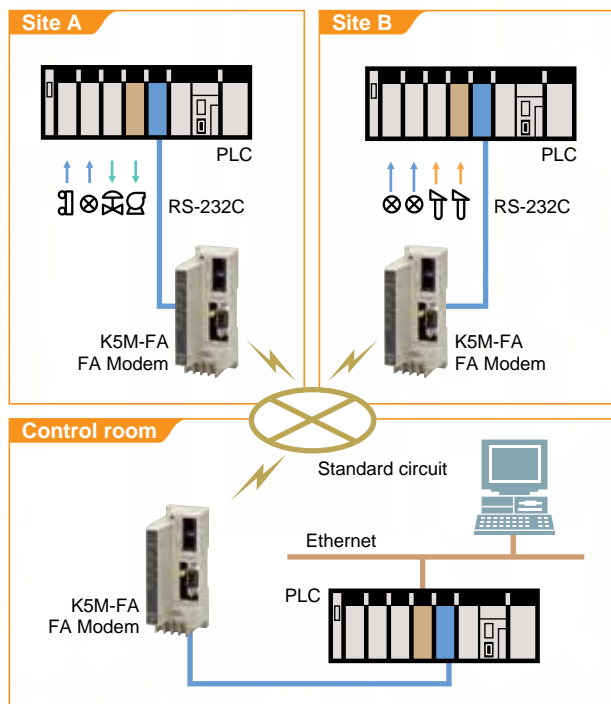

EXAMPLE 4 Using a Web Browser for Monitoring

The PLC is connected to an open network controller and the open network controller reads the PLC's data when the specified conditions are met. The desired data can even be monitored through the internet by accessing the open network controller from a web browser.

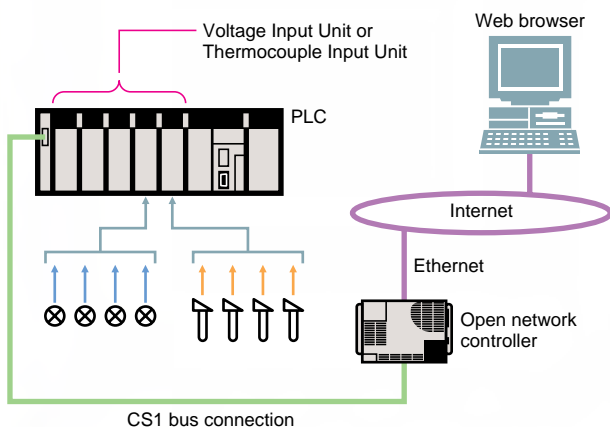

EXAMPLE 5 A Logging System for Buildings

This system works in combination with HMI software on personal computers to log and save data from chillers, boilers, and other building equipment. The Process Analog I/O Units can be used with a wide variety of sensors typically used in buildings, including Ni508.3-Ω sensors and 0 to 1-mA sensors for power transducers.

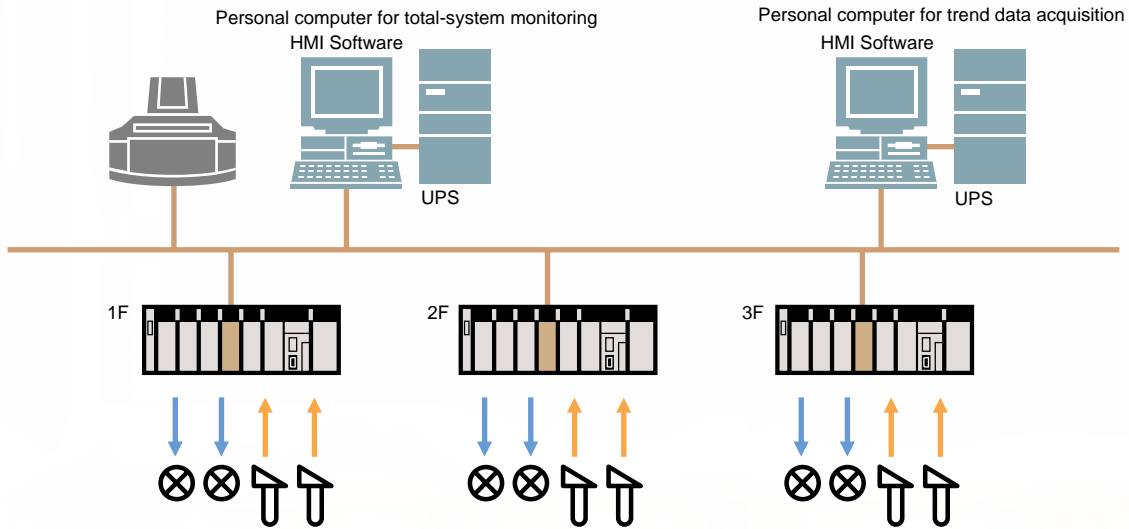

EXAMPLE 6 A Monitoring System for Waste Incineration Facilities

This system works in combination with HMI software on personal computers to monitor the temperature of an incineration facility and the amount of waste that is inserted. The data acquired by the PLC is collected at specific intervals for use as logging data. With its fast 10-ms data conversion speed, the CS1W-PDC11 Isolated-type DC Input Unit is able to log quickly changing data, such as that for flow rates and gas concentrations.

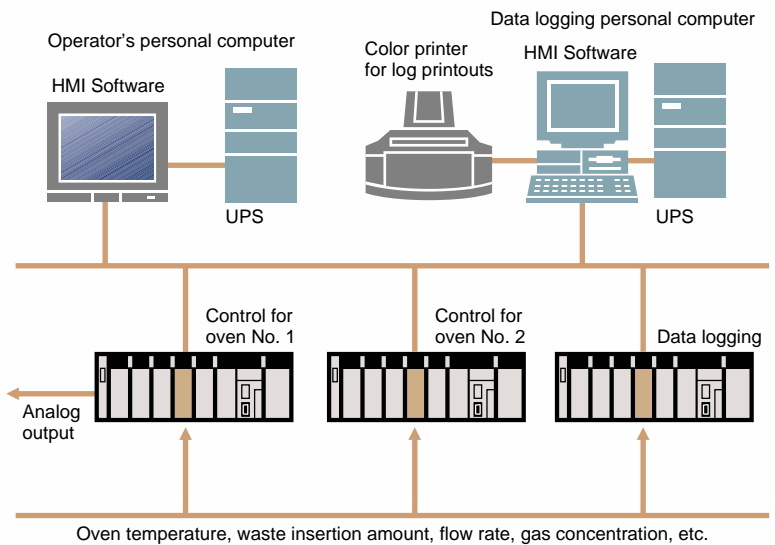
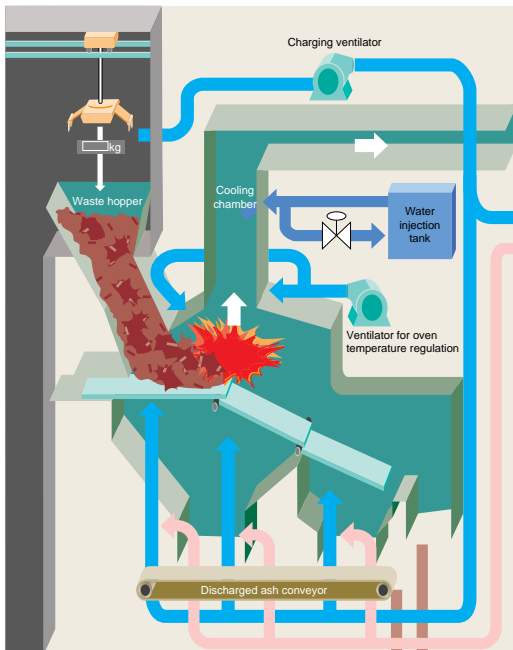

Additional Useful Functions

I/O Isolation

The Process Analog I/O Units listed below have isolation between inputs or outputs. Therefore sneak circuits do not develop between thermocouples or between the power supply's common voltage inputs, and the Units are much more resistant to effects from noise.

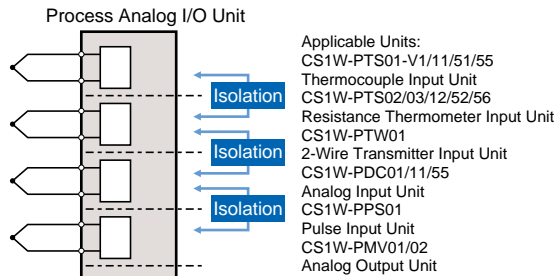

Process Value (or Instantaneous Value) Scaling in Engineering Units

This function takes the value scaled in engineering units with respect to the analog (or pulse) input signal's zero point and span point, and transfers it to the CPU Unit as the process value (or instantaneous value). Because of this, no ladder program is required at the CPU Unit for scaling.

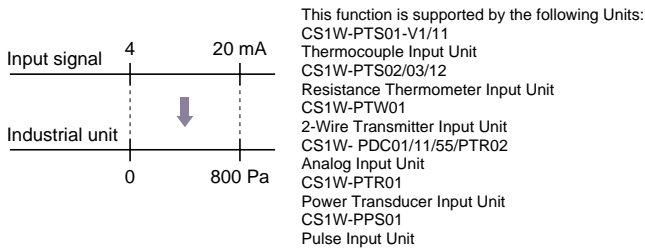

A Wide Range of Built-in Alarm Functions

Process Value Alarm

Either a 2-point alarm (H and L limits) or a 4-point alarm (HH, H, L, and LL limits) is possible for the process value (or instantaneous value).

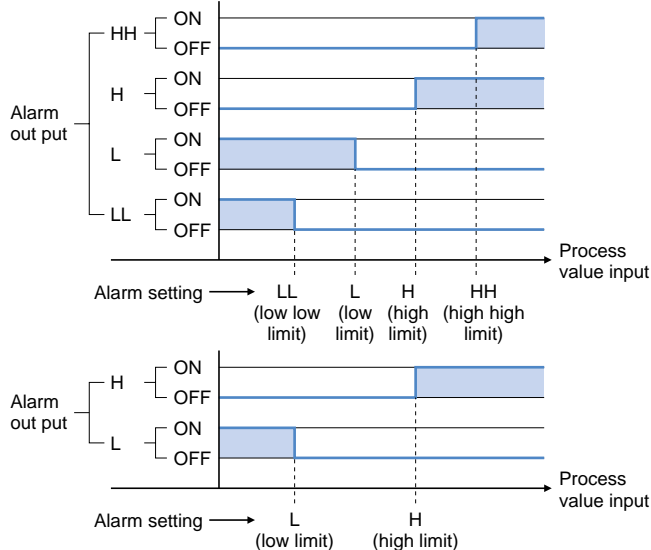

This function is supported by the following Units:
 4-point alarm Units
 CS1W-PTS01-V1/11 Thermocouple Input Unit
 CS1W-PTS02/03/12 Resistance Thermometer Input Unit
 CS1W-PTW01 2-Wire Transmitter Input Unit
 CS1W-PDC01/11/55/PTR02 Analog Input Unit
 CS1W-PPS01 Pulse Input Unit
 2-point alarm Units
 CS1W-PTS51/55 Thermocouple Input Unit
 CS1W-PTS52/56 Resistance Thermometer Input Unit
 CS1W-PDC55 Analog Input Unit
 CS1W-PTR01 Power Transducer Input Unit
 CS1W-PTR02 Analog Input Unit (100 mV)

Rate-of-change Calculation and Alarm

The Process Analog I/O Units listed below calculate the rate of change for the process value, and output an alarm when the high or low limit is exceeded. The rate-of-change value is derived by taking the difference each second between the process value at that time and the process value before the comparison time interval. The comparison time interval can be set from 1 to 16 seconds. This allows even a small process value rate of change to be detected.

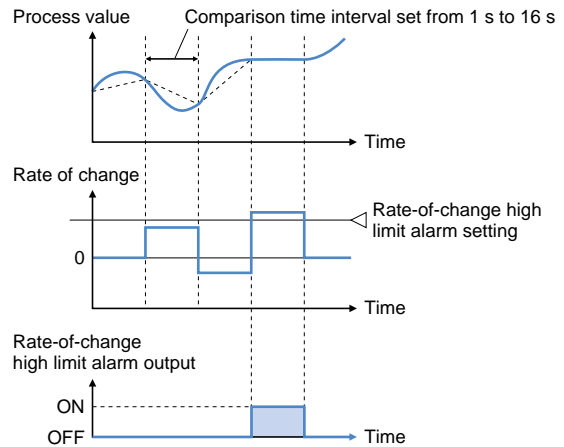

This function is supported by the following Units:
 CS1W-PTS01-V1/11 Thermocouple Input Unit
 CS1W-PTS02/03/12 Resistance Thermometer Input Unit
 CS1W-PTW01 2-Wire Transmitter Input Unit
 CS1W-PDC01/11 Analog Input Unit

Alarm Hysteresis

An hysteresis can be set for the process value (or instantaneous value) alarm and the rate-of-change alarm.

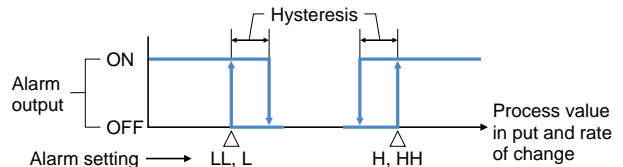

This function is supported by the following Units:
 CS1W-PTS01-V1/11/51/55 Thermocouple Input Unit
 CS1W-PTS02/03/12/52/56 Resistance Thermometer Input Unit
 CS1W-PTW01 2-Wire Transmitter Input Unit
 CS1W-PDC01/11/55/PTR02 Analog Input Unit
 CS1W-PTR01 Power Transducer Input Unit
 CS1W-PPS01 Pulse Input Unit

Alarm-ON Delay

This function can be used to set a given time period (0 s to 60 s) for delaying the turning ON of the alarm after the process value (or instantaneous value) alarm status or the alarm setting is reached.

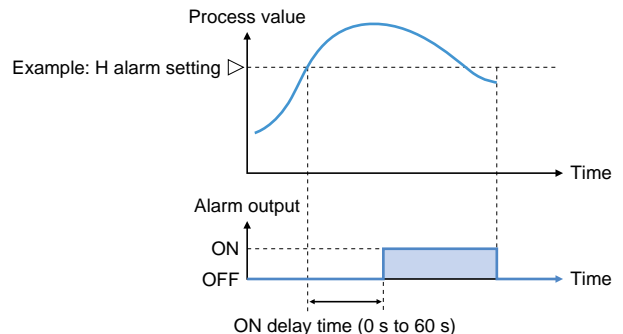

This function is supported by the following Units:
 CS1W-PTS01-V1/11/51/55 Thermocouple Input Unit
 CS1W-PTS02/03/12/52/56 Resistance Thermometer Input Unit
 CS1W-PTW01 2-Wire Transmitter Input Unit
 CS1W-PDC01/11/55/PTR02 Analog Input Unit
 CS1W-PTR01 Power Transducer Input Unit
 CS1W-PPS01 Pulse Input Unit

Data Measurement

New

●Peak/Bottom Hold, Top/Valley Hold

Peak and bottom, or top and valley analog input values can be detected to find fluctuations in input data or undulation in workpieces.

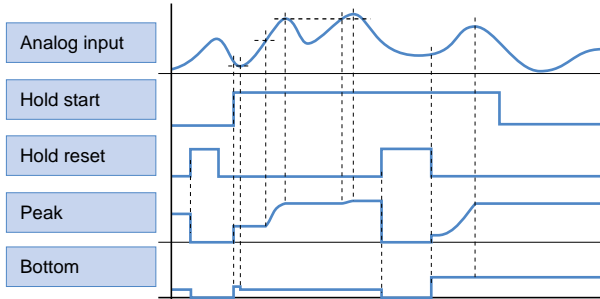

This function is supported by the following Units:
 CS1W-PTS11 Thermocouple Input Unit
 CS1W-PTS12 Resistance Thermometer Input Unit
 CS1W-PDC11 Analog Input Unit

●Analog Integration

New

Time integration calculations can be done for analog input. For example, the total usage amount of a fluid can be calculated from its flow rate to detect leaks.

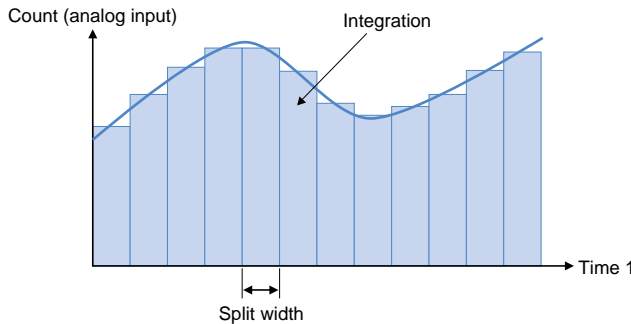

This function is supported by CS1W-PDC11 Analog Input Units only.

Inrush Input Limit

The inrush input limit function temporarily stops the process value input exceeding a given set value (the high limit) when it increases from a low value (2%). This function is used for preventing a process value alarm from being generated by the inrush current, e.g., when the motor is started.

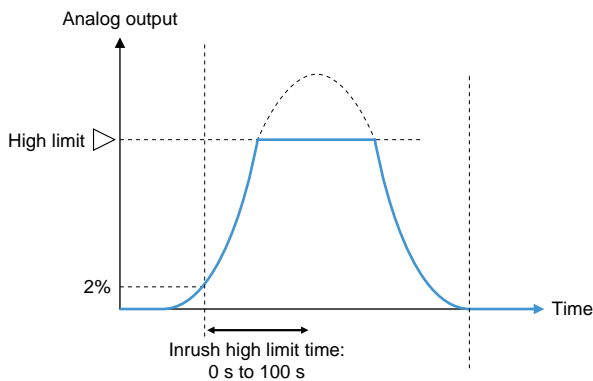

This function is supported by the following Units:
 CS1W-PTR01 Power Transducer Input Unit
 CS1W-PTR02 Analog Input Unit (100 mV)

Zero/Span Adjustment

New

The zero point and span can be adjusted for the process value at any specified point without halting PLC operation. The set data can also be adjusted and recorded according to the customer's maintenance cycle.

Channel	Last adjustment day	Effective deadline	Effective deadline
1	July 3, 2003	180 days	30 days before
2	July 3, 2003	180 days	30 days before
3	October 3, 2003	60 days	10 days before
4	October 3, 2003	60 days	10 days before

The Unit detects the adjustment operation, and records the date. It compares this with the present date and reports if the set conditions are met.

For input channel 1
 July 3, 2003: Zero/span adjustment executed.
 November 30, 2003: Zero/Span Adjustment Deadline Notice Flag ON.
 December 30, 2003: Zero/Span Adjustment Deadline Expiration Flag ON.

This function is supported by the following Units:
 CS1W-PTS11 Thermocouple Input Unit
 CS1W-PTS12 Resistance Thermometer Input Unit
 CS1W-PDC11 Analog Input Unit

Pulse Input Instantaneous Value Conversion

This function counts the number of pulses per time unit and converts the number to an instantaneous value (pulses/time unit). Any of the following time units can be selected: 1 s, 3 s, 10 s, 30 s, or 60 s. (These match the cycles for conversion to instantaneous values.)

This function is supported by CS1W-PPS01 Pulse Input Units only.

Answer Input

During analog output, the actual analog output (current or voltage) signal can be checked by being read again from the analog output terminals. This function is used for checking for actual output load discrepancies due to external load resistance, or for checking actual analog signal values when an output rate-of-change limit is used.

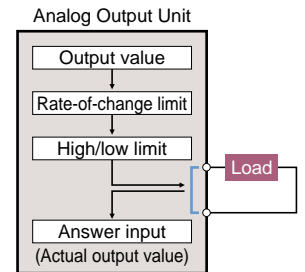

This function is supported by CS1W-PMV01 Analog Output Units only.

Output Disconnection Detection

If a current loop is disconnected during analog output, this function will detect it.

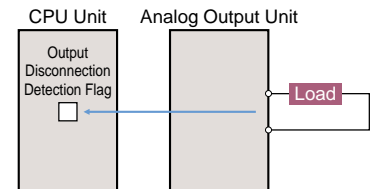

This function is supported by CS1W-PMV01 Analog Output Units only.

Output Hold When CPU Unit Error Occurs

When a fatal error (including user-defined FALS execution), or a CPU error in the CPU Unit occurs, or all outputs are turned OFF with the Output OFF Bit, this function can hold either a preset value or the analog output value prior to the error. When the CPU Unit is restored to normal operation, the output value in the CIO Area is output.

This function is supported by CS1W-PMV01/02 Analog Output Units only.

Functions

Process Analog I/O Units and Analog I/O Units

Outline

A wide range of 24 I/O Units, including 16 Isolated-type Units, covers almost all typical applications. Also featuring high-speed (10 ms) and high-resolution (1/64,000) types, this line-up meets a diverse array of potential uses, from data logging to high-speed measurement control.

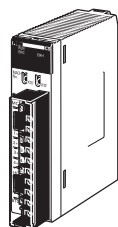

CS1W-PTS11

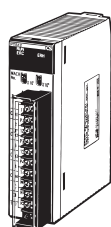

CS1W-PTS12

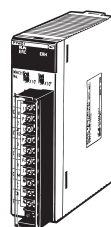

CS1W-PTW01

Features

- Dramatic reductions in installation cost, space, and set-up steps are attained by eliminating the need for external setters and converters.
- Process value alarms and rate-of-change calculations can be executed from temperature and analog inputs.
- Rate-of-change limits and high/low output limits calculated for analog output.
- Peak and bottom, or top and valley hold functions can be used for process values. (CS1W-P□□1□ only.)
- Zero point and span can be adjusted for any specified range, and adjustment days and times can be automatically saved. The adjustment deadline and adjustment deadline expiration notice can also be set and notification given. (CS1W-P□□1□ only.)
- Changes exceeding a set threshold can be counted, and analog input values can be integrated. (CS1W-P□□1□ only.)

Overview of Process Analog I/O Functions

Name	Model	Number of I/O	Field I/O isolation	I/O type	Main specifications *	Main functions
Isolated-type Thermocouple Input Unit (high-resolution type)	CS1W-PTS11	4 inputs	All inputs are isolated.	B, E, J, K, L, N, R, S, T, U, WRe5-26, PLII, ±100 mV	Standard accuracy: ±0.05% of F.S. Temperature coefficient: ±0.01%/°C Resolution: 1/64,000 Conversion period: 20 ms/4 points, 10 ms/2 points	Output scaling (±32,000) Process value alarms (HH, H, L, LL) Rate-of-change calculation and alarm Input disconnection alarm Top/bottom/valley hold Zero/span adjustment for any specified range
Isolated-type Resistance Thermometer Input Unit (high-resolution type)	CS1W-PTS12	4 inputs	All inputs are isolated.	Pt100 (JIS, IEC) JPt100 Ω, Pt50 Ω Ni100 Ω	Standard accuracy: ±0.05% of F.S. or ±0.1°C, whichever is larger Temperature coefficient: ±0.009%/°C Resolution: 1/64,000 Conversion period: 20 ms/4 points, 10 ms/2 points	Output scaling (±32,000) Process value alarms (HH, H, L, LL) Rate-of-change calculation and alarm Input disconnection alarm Top/bottom/valley hold Zero/span adjustment for any specified range
Isolated-type DC Input Unit (high-resolution type)	CS1W-PDC11	4 inputs	All inputs are isolated.	4 to 20 mA, 0 to 20 mA, 0 to 10 V, ±10 V, 0 to 5 V, ±5 V, 1 to 5 V, 0 to 1.25 V, ±1.25 V	Standard accuracy: ±0.05% of F.S. Temperature coefficient: ±0.008%/°C Resolution: 1/64,000 Conversion period: 20 ms/4 points, 10 ms/2 points	Output scaling (±32,000) Process value alarms (HH, H, L, LL) Rate-of-change calculation and alarm Input disconnection alarm Top/bottom/valley hold Integrated value measurement Zero/span adjustment for any specified range
Isolated-type Thermocouple Input Unit (economical type)	CS1W-PTS51	4 inputs	All inputs are isolated.	R, S, K, J, T, L, B	Centigrade Selected Total accuracy: ±0.3% of PV or ±1°C, whichever is larger, ±1 digit max. Fahrenheit Selected ±0.3% of PV or 2°F, whichever is larger, ±1 digit max. Conversion period: 250 ms/Unit	Process value alarms (H, L) Input disconnection alarm
	CS1W-PTS55	8 inputs				
Isolated-type Resistance Thermometer Input Unit (economical type)	CS1W-PTS52	4 inputs	All inputs are isolated.	JPt100, Pt100 (JIS, IEC)	Centigrade Selected Total accuracy: ±0.3% of PV or ±0.8°C, whichever is larger, ±1 digit max. Fahrenheit Selected ±0.3% of PV or 1.6°F, whichever is larger, ±1 digit max. Conversion period: 250 ms/Unit	Process value alarms (H, L) Input disconnection alarm
	CS1W-PTS56	8 inputs				
Isolated-type DC Input Unit (economical type)	CS1W-PDC55	8 inputs	All inputs are isolated.	4 to 20 mA, 0 to 10 V, 0 to 5 V, 1 to 5 V	Standard accuracy: ±0.3% of F.S. Resolution: 1/16,000 Conversion period: 250 ms/8 inputs	Process value alarms (H, L) Input disconnection alarm
Isolated-type Thermocouple Input Unit	CS1W-PTS01-V1	4 inputs	All inputs are isolated.	B, E, J, K, N, R, S, T, ±80-mV DC range	Standard accuracy: ±0.1% Temperature coefficient: ±0.015%/°C Resolution: 1/4,096 Conversion period: 150 ms/4 points	Variable range setting Output scaling (±32,000) Process value alarms (HH, H, L, LL) Rate-of-change calculation and alarm Input disconnection alarm
Isolated-type Resistance Thermometer Input Unit	CS1W-PTS02	4 inputs	All inputs are isolated.	Pt100 (JIS, IEC) JPt100	Standard accuracy: ±0.1% or ±0.1°C, whichever is larger Temperature coefficient: ±0.015%/°C Resolution: 1/4,096 Conversion period: 100 ms/4 points	Variable range setting Output scaling (±32,000) Process value alarms (HH, H, L, LL) Rate-of-change calculation and alarm Input disconnection alarm
Isolated-type Resistance Thermometer Input Unit (Ni508.4 Ω)	CS1W-PTS03	4 inputs	All inputs are isolated.	Ni508.4 Ω	Standard accuracy: ±0.2% or ±0.2°C, whichever is larger Temperature coefficient: ±0.015%/°C Resolution: 1/4,096 Conversion period: 100 ms/4 points	Variable range setting Output scaling (±32,000) Process value alarms (HH, H, L, LL) Rate-of-change calculation and alarm Input disconnection alarm
Isolated-type 2-Wire Transmitter Input Unit	CS1W-PTW01	4 inputs	All inputs are isolated.	4 to 20 mA, 1 to 5 V	Standard accuracy: ±0.2% Temperature coefficient: ±0.015%/°C Resolution: 1/4,096 Conversion period: 100 ms/4 points	Built-in power supply for 2-wire transmitter Output scaling (±32,000) Process value alarms (HH, H, L, LL) Rate-of-change calculation and alarm Square root Input error alarm

*Vary depending on usage conditions. Refer to Analog I/O Units User's Manual (Cat. No. W368).

Name	Model	Number of I/O	Field I/O isolation	I/O type	Main specifications *	Main functions
Isolated-type Analog Input Unit	CS1W-PDC01	4 inputs	All inputs are isolated.	± 10 V, 0 to 10 V, ± 5 V, 0 to 5 V, 1 to 5 V, ± 10 VDC range 4 to 20 mA, 0 to 20 mA	Standard accuracy: $\pm 0.1\%$ Temperature coefficient: $\pm 0.015\%/^{\circ}\text{C}$ Resolution: 1/4,096 Conversion period: 100 ms/4 points	Process value alarms (HH, H, L, LL) Output scaling ($\pm 32,000$) Rate-of-change calculation and alarm Square root Input error alarm
Isolated-type Pulse Input Unit	CS1W-PPS01	4 inputs	All inputs are isolated.	Max. counting speed: 20 k pulses/s (voltage input or no-voltage semiconductor input) 20 pulses/s (contact input)	—	Built-in sensor power supply Contact bounce filter Unit pulse conversion Accumulated value output Instantaneous value output, 4 instantaneous value alarms
Isolated-type Analog Output Unit	CS1W-PMV01	4 outputs	All outputs are isolated.	4 to 20 mA, 1 to 5 V	Standard accuracy: $\pm 0.1\%$ (4 to 20 mA) Standard accuracy: $\pm 0.2\%$ (1 to 5 V) Temperature coefficient: $\pm 0.015\%/^{\circ}\text{C}$ Resolution: 1/4,000 (outputs) Conversion period: 100 ms/4 points	Output disconnection alarms Control output answerback input Output rate-of-change limit Output high/low limits
	CS1W-PMV02	4 outputs	All outputs are isolated.	0 to 10 V, ± 10 V, 0 to 5 V, ± 5 V, 0 to 1 V, ± 1 V	Standard accuracy: $\pm 0.1\%$ Temperature coefficient: $\pm 0.015\%/^{\circ}\text{C}$ Resolution (Full scale) ± 10 V and ± 1 V: 1/16,000 0 to 10 V, 0 to 1 V, and ± 5 V: 1/8,000 0 to 5 V: 1/4,000 Conversion period: 40 ms/4 points	Output rate-of-change limit Output high/low limits Output scaling ($\pm 32,000$)
Power Transducer Input Unit	CS1W-PTR01	8 inputs	Isolated between inputs and PLC signals. No isolation between inputs.	± 1 mA, 0 to 1 mA	Standard accuracy: $\pm 0.2\%$ Temperature coefficient: $\pm 0.015\%/^{\circ}\text{C}$ Resolution: 1/4,096 Conversion period: 200 ms/8 points	Anti-overshooting at motor startup Process value alarm (H, L) Output scaling ($\pm 32,000$)
Analog Input Unit (100 mV)	CS1W-PTR02	8 inputs	Isolated between inputs and PLC signals. No isolation between inputs.	± 100 mV, 0 to 100 mV	Standard accuracy: $\pm 0.2\%$ Temperature coefficient: $\pm 0.015\%/^{\circ}\text{C}$ Resolution: 1/4,096 Conversion period: 200 ms/8 points	Process value alarm (H, L) Output scaling ($\pm 32,000$)

*Vary depending on usage conditions. Refer to *Analog I/O Units User's Manual* (Cat. No. W368).

■ Overview of Analog I/O Functions

Name	Model	Number of I/O	Field I/O isolation	I/O signal range	Main specifications
Analog Input Units	CS1W-AD041-V1	4 inputs	Isolated between inputs and PLC signals. No isolation between inputs.	1 to 5 V, 0 to 5 V, 0 to 10 V, -10 to 10 V, 4 to 20 mA	Voltage input: $\pm 0.2\%$ of F.S.; current input $\pm 0.4\%$ of F.S. ($23 \pm 2^{\circ}\text{C}$) Voltage input: $\pm 0.4\%$ of F.S.; current input $\pm 0.6\%$ of F.S. (0 to 55°C) Resolution: 1/8,000*, Conversion speed: 250 $\mu\text{s}/\text{point max.}$ * (Can be used with a resolution of 1/4,000 and conversion speed of 1 ms.)
	CS1W-AD081-V1	8 inputs	Isolated between inputs and PLC signals. No isolation between inputs.	1 to 5 V, 0 to 5 V, 0 to 10 V, -10 to 10V, 4 to 20 mA	Voltage input: $\pm 0.2\%$ of F.S.; current input $\pm 0.4\%$ of F.S. ($23 \pm 2^{\circ}\text{C}$) Voltage input: $\pm 0.4\%$ of F.S.; current input $\pm 0.6\%$ of F.S. (0 to 55°C) Resolution: 1/8,000*, Conversion speed: 250 $\mu\text{s}/\text{point max.}$ * (Can be used with a resolution of 1/4,000 and conversion speed of 1 ms.)
Analog Output Units	CS1W-DA041	4 outputs	Isolated between outputs and PLC signals. No isolation between inputs.	1 to 5 V, 0 to 5 V, 0 to 10 V, -10 to 10 V, 4 to 20 mA	Voltage output: $\pm 0.3\%$ of F.S.; current output $\pm 0.5\%$ of F.S. ($23 \pm 2^{\circ}\text{C}$) Voltage output: $\pm 0.5\%$ of F.S.; current output $\pm 0.8\%$ of F.S. (0 to 55°C) Resolution: 1/4,000, Conversion speed: 1 ms/point max.
	CS1W-DA08V	8 outputs	Isolated between outputs and PLC signals. No isolation between inputs.	1 to 5 V, 0 to 5 V, 0 to 10 V, -10 to 10 V	$\pm 0.3\%$ of F.S. ($23 \pm 2^{\circ}\text{C}$) $\pm 0.5\%$ of F.S. (0 to 55°C) Resolution: 1/4,000, Conversion speed: 1 ms/point max.
	CS1W-DA08C	8 outputs	Isolated between outputs and PLC signals. No isolation between inputs.	4 to 20 mA	$\pm 0.5\%$ of F.S. ($23 \pm 2^{\circ}\text{C}$) $\pm 0.8\%$ of F.S. (0 to 55°C) Resolution: 1/4,000, Conversion speed: 1 ms/point max.
Analog I/O Unit	CS1W-MAD44	4 inputs and 4 outputs	Isolated between inputs and PLC signals. No isolation between inputs.	Inputs: 1 to 5 V, 0 to 5 V, 0 to 10 V, -10 to 10 V, or 4 to 20 mA Outputs: 1 to 5 V, 0 to 5 V, 0 to 10 V, -10 to 10 V	Voltage input: $\pm 0.2\%$ of F.S.; current input $\pm 0.4\%$ of F.S. ($23 \pm 2^{\circ}\text{C}$) Voltage input: $\pm 0.4\%$ of F.S.; current input $\pm 0.6\%$ of F.S. (0 to 55°C) Output: $\pm 0.3\%$ of F.S. ($23 \pm 2^{\circ}\text{C}$) Output: $\pm 0.5\%$ of F.S. (0 to 55°C) I/O resolution: 1/4,000, Conversion speed: 1 ms/point max.

*The resolution and conversion speed can be switched with a DM setting.

If it isn't necessary to change the setting, the Unit can be used with the earlier model's mode (resolution of 1/4,000 and conversion speed of 1 ms) just like the conventional model.

Guide to Selection

■ Analog Input

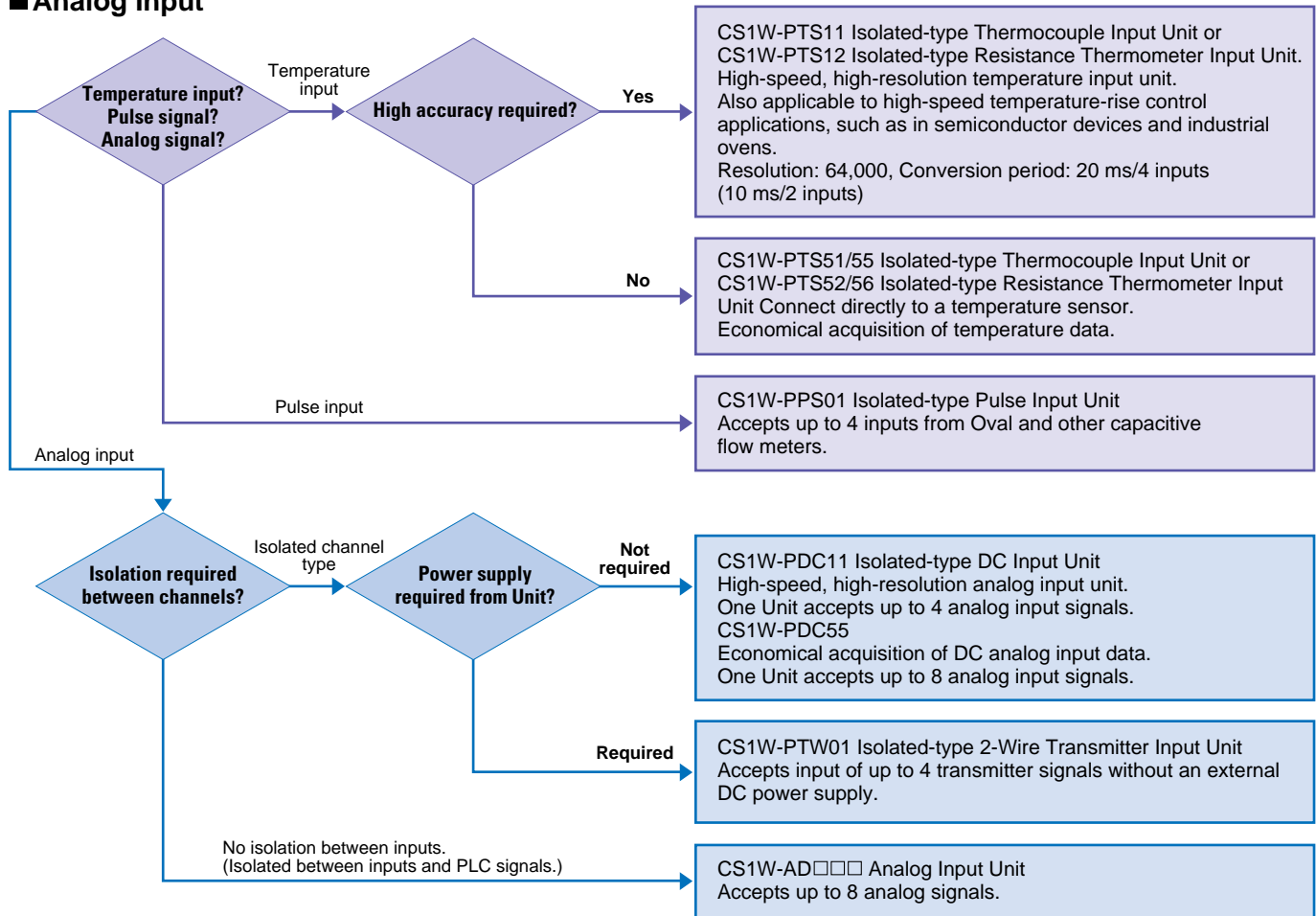



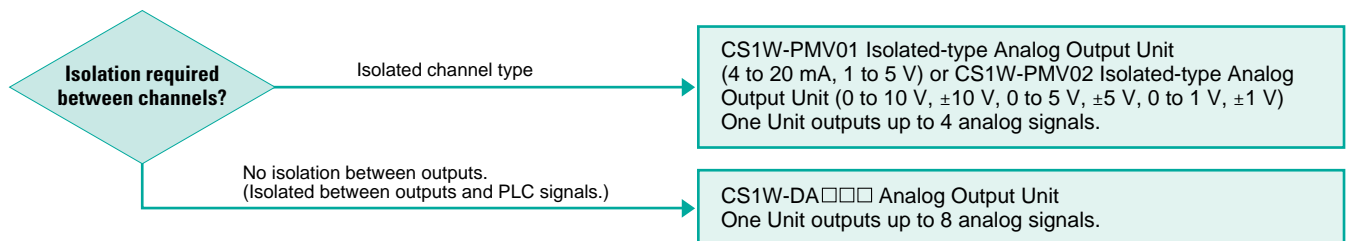

*A Power Transducer Input Unit (± 1 mA, 0 to 1 mA) and an Analog I/O Unit with 0 to 100 mV I/O are also available. Refer to the Overview of Process Analog I/O Functions on page 10 for details.

■ Analog Output

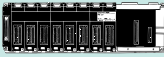

Ordering Guide

■ Basic Components

Name	Specifications			Model	International Standards
	I/O bits	Program capacity	Data Memory capacity		
CPU Units 	5,120	250K steps	Data Memory: 448K words (DM: 32K words, EM: 32K words x 13 banks)	CS1H-CPU67H	UC1, N, L, CE
	5,120	120K steps	Data Memory: 256K words (DM: 32K words, EM: 32K words x 7 banks)	CS1H-CPU66H	
	5,120	60K steps	Data Memory: 128K words (DM: 32K words, EM: 32K words x 3 banks)	CS1H-CPU65H	
	5,120	30K steps	Data Memory: 64K words (DM: 32K words, EM: 32K words x 1 bank)	CS1H-CPU64H	
	5,120	20K steps	Data Memory: 64K words (DM: 32K words, EM: 32K words x 1 bank)	CS1H-CPU63H	
	5,120	60K steps	Data Memory: 128K words (DM: 32K words, EM: 32K words x 3 banks)	CS1G-CPU45H	
	1,280	30K steps	Data Memory: 64K words (DM: 32K words, EM: 32K words x 1 bank)	CS1G-CPU44H	
	960	20K steps	Data Memory: 64K words (DM: 32K words, EM: 32K words x 1 bank)	CS1G-CPU43H	
	960	10K steps	Data Memory: 64K words (DM: 32K words, EM: 32K words x 1 bank)	CS1G-CPU42H	
CPU Backplanes 	2 slots (Connection is not possible to Expansion Backplane.)			CS1W-BC023	U, C, N, L, CE
	3 slots			CS1W-BC033	
	5 slots			CS1W-BC053	
	8 slots			CS1W-BC083	
	10 slots			CS1W-BC103	
Power Supply Units 	100 to 120 VAC or 200 to 240 VAC, Output capacity: 4.6 A, 5 VDC			C200HW-PA204	U, C, N, L, CE
	100 to 120 VAC or 200 to 240 VAC (0.8 A 24 VDC service power), Output capacity: 4.6 A, 5 VDC			C200HW-PA204S	
	100 to 120 VAC or 200 to 240 VAC (with RUN output), Output capacity: 4.6 A, 5 VDC			C200HW-PA204R	U, C
	100 to 120 VAC or 200 to 240 VAC (with RUN output), Output capacity: 9 A, 5 VDC			C200HW-PA209R	U, C, N, L, CE
	24 VDC, Output capacity: 4.6 A, 5 VDC			C200HW-PD024	UC1, N, L, CE
	100 VDC, Output capacity: 6 A, 5 VDC			C200HW-PD106R	UC
Memory Cards 	Flash memory, 15 MB			HMC-EF172	L, CE
	Flash memory, 30 MB			HMC-EF372	
	Flash memory, 64 MB			HMC-EF672	
	Memory Card adapter (for PCMCIA slot of PC)			HMC-AP001	CE
Serial Communications Boards	2 x RS-232C ports, protocol macro function			CS1W-SCB21-V1	U, C, N, L, CE
	1 x RS-232C port + 1 x RS-422/485 port, protocol macro function			CS1W-SCB41-V1	
Programming Consoles 	An English Keyboard Sheet (CS1W-KS001-E) is required.		Note : Can connect through the CPU Unit's peripheral port only. (Cannot connect through an RS-232C port.)	CQM1H-PRO01-E	U, C, CE
	An English Keyboard Sheet (CS1W-KS001-E) is required.			CQM1-PRO01-E	U, C, N, CE
	An English Keyboard Sheet (CS1W-KS001-E) is required.			C200H-PRO27-E	
Programming Console Keyboard Sheet	For the C200H-PRO27 and CQM1-PRO01 Programming Consoles			CS1W-KS001-E	CE
Programming Console Connection Cables 	Connects the CQM1-PRO01-E Programming Console. (Length: 0.05 m)			CS1W-CN114	
	Connects the C200H-PRO27-E Programming Console. (Length: 2 m)			CS1W-CN224	
	Connects the C200H-PRO27-E Programming Console. (Length: 6 m)			CS1W-CN624	

Ordering Guide

■ Support Software and Connection Cables

Name	Specifications	Model	International Standards
CX-Programmer	Ladder Programming Tool software for Windows 95/98/Me/NT4.0/2000/XP	WS02-CXPC1-E-V4□	—
		WS02-CXPC1-EL03-V4 □	
		WS02-CXPC1-EL10-V4 □	
CX-Process	Loop Control Board/Loop Control Unit Programming Tool software for Windows 95/98/Me/NT4.0/2000/XP	WS02-LCTC1-EV3	
		WS02-LCTC1-EV3L03	
		WS02-LCTC1-EV3L10	
CX-Process Monitor Plus	Loop Control Board/Loop Control Unit Monitor Tool software for Windows NT4.0/2000/XP	WS02-LCMC1-E	
		WS02-LCMC1-EL03	
		WS02-LCMC1-EL10	
Analog I/O Unit Support Software	Setting tool software for the Processing I/O Units, Applicable models: CS1W-P□□□□/AD□□□□/DA□□□□/MA□□□□ CJ1W-AD□□□□/DA□□□□/MA□□□□ Windows 95/98/NT4.0/2000	WS02-PUTC1-E	
CX-Simulator	Ladder Simulation Tool for Windows 95/98/Me/NT4.0/2000/XP	WS02-SIMC1-E	
CX-Protocol	Protocol Creation Tool for Windows 95/98/Me/NT4.0/2000/XP	WS02-PSTC1-E	
Peripheral Port Connecting Cables for Process Tool and Monitor Software (personal computer)	Connects an IBM PC/AT or compatible personal computer, D-Sub 9-pin (Length: 2.0 m)	Conversion cable when connecting an RS-232C cable to peripheral port	CE
	Connects an IBM PC/AT or compatible personal computer, D-Sub 9-pin (Length: 6.0 m)		
Peripheral Device Connecting Cables (for RS-232C port)	Connects an IBM PC/AT or compatible personal computer, D-Sub 9-pin (Length: 2.0 m)	Can be used for Host Link connection only. Cannot be used for peripheral bus connection.	—
	Connects an IBM PC/AT or compatible personal computer, D-Sub 9-pin (Length: 5.0 m)		
USB Serial Conversion Cable	USB-RS-232C conversion cable (length: 0.5 m) with driver for connection with personal computer (CD-ROM) USB 1.1 compliant Personal computer cable end: USB (male "A" plug connector) PLC cable end: RS-232C (male D-sub 9-pin connector) Driver supported by Windows 98/Me/2000/XP.	CS1W-CIF31	—

■ Process Analog I/O Units

Name	Specifications	Model	International Standards
Isolated-type Thermocouple Input Unit (high-resolution type)	4 inputs, B, E, J, K, L, N, R, S, T, U, WRe5-26, PL II, ±100 mV	CS1W-PTS11	UC1, CE, N
Isolated-type Resistance Thermometer Input Unit (high-resolution type)	4 inputs, Pt100 Ω (JIS, IEC), JPt100 Ω, Pt50 Ω, Ni508.4 Ω	CS1W-PTS12	
Isolated-type DC Input Unit (high-resolution type)	4 inputs, 4 to 20 mA, 0 to 20 mA, 0 to 10 V, ±10 V, 0 to 5 V, ±5 V, 1 to 5 V, 0 to 1.25 V, ±1.25 V	CS1W-PDC11	
Isolated-type Thermocouple Input Unit (economical type)	4 inputs, R, S, K, J, T, L, B	CS1W-PTS51	UC1, CE
	8 inputs, R, S, K, J, T, L, B	CS1W-PTS55	
Isolated-type Resistance Thermometer Input Unit (economical type)	4 inputs, JPt100, Pt100 (JIS, IEC)	CS1W-PTS52	
	8 inputs, JPt100, Pt100 (JIS, IEC)	CS1W-PTS56	
Isolated-type Analog Input Unit (economical type)	8 inputs, 4 to 20 mA, 0 to 10 V, 0 to 5 V, 1 to 5 V	CS1W-PDC55	
Isolated Thermocouple Input Unit	4 inputs, B, E, J, K, N, R, S, T ±80 mV	CS1W-PTS01-V1	
Isolated-type Resistance Thermometer Input Unit	4 inputs, Pt100, JPt100	CS1W-PTS02	
Isolated-type Resistance Thermometer Input Unit (Ni508.4 Ω)	4 inputs, Ni508.4 Ω	CS1W-PTS03	
Isolated-type 2-wire Transmitter Input Unit	4 inputs, 4 to 20 mA, 1 to 5 V	CS1W-PW01	
Isolated-type Analog Input Unit	4 inputs, 4 to 20 mA, 0 to 20 mA, 1 to 5 V, 0 to 5 V, ±5 V, 0 to 10 V, ±10 V	CS1W-PDC01	
Isolated-type Pulse Input Unit	4 inputs, Max. counting speed: 20 k pulses/s or 20 pulses/s	CS1W-PPS01	
Isolated-type Analog Output Unit	4 outputs, 4 to 20 mA, 1 to 5 V	CS1W-PMV01	
Isolated-type Analog Output Unit	4 outputs, 0 to 10 V, ±10 V, 0 to 5 V, ±5 V, 0 to 1 V, ±1 V	CS1W-PMV02	
Power Transducer Input Unit	8 inputs, 0 to 1 mA, ±1 mA	CS1W-PTR01	
Analog Input Unit (100 mV)	8 inputs, 0 to 100 mV, ±100 mV	CS1W-PTR02	

■ Analog I/O Units

Name	Specifications	Model	International Standards
Analog Input Units	4 inputs (1 to 5 V, 0 to 5 V, 0 to 10 V, -10 to 10 V, 4 to 20 mA) Resolution: 1/8,000 (See note.)	CS1W-AD041-V1	U, C, N, L, CE
	8 inputs (1 to 5 V, 0 to 5 V, 0 to 10 V, -10 to 10 V, 4 to 20 mA) Resolution: 1/8,000 (See note.)	CS1W-AD081-V1	
Analog Output Units	4 outputs (1 to 5 V, 0 to 5 V, 0 to 10 V, -10 to 10 V, 4 to 20 mA) Resolution: 1/4,000	CS1W-DA041	U, C, N, CE
	8 outputs (1 to 5 V, 0 to 5 V, 0 to 10 V, -10 to 10 V) Resolution: 1/4,000	CS1W-DA08V	
	8 outputs (4 to 20 mA) Resolution: 1/4,000	CS1W-DA08C	
Analog I/O Unit	4 inputs (1 to 5 V, 0 to 5 V, 0 to 10 V, -10 to 10 V, 4 to 20 mA) Resolution: 1/4,000	CS1W-MAD44	U, C, N, L, CE
	4 outputs (1 to 5 V, 0 to 5 V, 0 to 10 V, -10 to 10 V) Resolution: 1/4,000		

*Resolution can conversion speed can be switched by a DM setting. Unless otherwise set, the conventional mode (resolution: 1/4,000, conversion speed: 1 ms) will be used.

■ Loop Control Board/Unit

Name	Specifications	Model	International Standards
Loop Control Board (LCB)	Function blocks: 50 max.	CS1W-LCB01	UC1, CE
	Function blocks: 500 max.	CS1W-LCB05	
Loop Control Unit (LCU)	Control loops: 32 max. Processes: 249 max.	CS1W-LC001	UC1, N, CE

■ Middleware

Name	Specifications	Model	International Standards
SYSMAC Compolet Version 2003	Software components for PLC communications Windows 2000/XP	SCPL-SYS-2003E	—
PLC Reporter	Simple data acquisition software components (host link version) Windows 98/Me/2000/XP	SDKY-95HLK-E97	
	Simple data acquisition software components (multi-network version) Windows 98/Me/2000/XP	SDKY-95MLT-E97	
FinsGateway Version 2003	Communications middleware Windows 2000/XP	SFGW-RT-2003E	

International Standards

- Meets or exceeds the following international standards (as of January 31, 2004): UL, CSA, cULus, cUL, NK, Lloyd's, and the EC Directives.
(U: UL, U1: UL (Class 1, Div. 2 Hazardous Locations Certification), C: CSA, UC: cULus, UC1: cULus (Class 1, Div. 2 Hazardous Locations Certification), CU: cUL, N: NK, L: Lloyd's, CE: EC Directives)
- Contact your OMRON representative for questions regarding operating conditions.

Refer to *SYSMAC CS1 Programmable Controllers (P047)* for more details on CS-series Special I/O Units, I/O Units, and general specifications.
Refer to *PLC-based Process Controller (P051)* for more details on the Loop Control Boards.

Products Ideally Suited to Monitoring

Open Network Controller

ITNC-EPX01 (-□□□) Ver. 2

ITNC-EIS01 (-□□□) Ver. 1 Basic Model

ITNC-EIX01 (-□□□) Ver. 1 Expansion Model

This compact Network Controller for FA sites provides an ideal tool for transferring FA site information over the internet.

- Can be connected to a SYSMAC CS1 PLC through the CS1 Bus.
- All equipment and devices at the FA site can be monitored over the internet.
- Can communicate with various kinds of computer equipment and control equipment.
- Provides highly reliable operation even in harsh environments.



Refer to
Cat. No. V204
for details.

Warranty and Limitations of Liability

WARRANTY

OMRON's exclusive warranty is that the products are free from defects in materials and workmanship for a period of one year (or other period if specified) from date of sale by OMRON.

OMRON MAKES NO WARRANTY OR REPRESENTATION, EXPRESS OR IMPLIED, REGARDING NON-INFRINGEMENT, MERCHANTABILITY, OR FITNESS FOR PARTICULAR PURPOSE OF THE PRODUCTS. ANY BUYER OR USER ACKNOWLEDGES THAT THE BUYER OR USER ALONE HAS DETERMINED THAT THE PRODUCTS WILL SUITABLY MEET THE REQUIREMENTS OF THEIR INTENDED USE. OMRON DISCLAIMS ALL OTHER WARRANTIES, EXPRESS OR IMPLIED.

LIMITATIONS OF LIABILITY

OMRON SHALL NOT BE RESPONSIBLE FOR SPECIAL, INDIRECT, OR CONSEQUENTIAL DAMAGES, LOSS OF PROFITS, OR COMMERCIAL LOSS IN ANY WAY CONNECTED WITH THE PRODUCTS, WHETHER SUCH CLAIM IS BASED ON CONTRACT, WARRANTY, NEGLIGENCE, OR STRICT LIABILITY.

In no event shall the responsibility of OMRON for any act exceed the individual price of the product on which liability is asserted.

IN NO EVENT SHALL OMRON BE RESPONSIBLE FOR WARRANTY, REPAIR, OR OTHER CLAIMS REGARDING THE PRODUCTS UNLESS OMRON'S ANALYSIS CONFIRMS THAT THE PRODUCTS WERE PROPERLY HANDLED, STORED, INSTALLED, AND MAINTAINED AND NOT SUBJECT TO CONTAMINATION, ABUSE, MISUSE, OR INAPPROPRIATE MODIFICATION OR REPAIR.

Note: Do not use this document to operate the Unit.

OMRON Corporation

FA Systems Division H.Q.

66 Matsumoto
Mishima-city, Shizuoka 411-8511
Japan
Tel: (81)55-977-9181
Fax: (81)55-977-9045

Regional Headquarters

OMRON EUROPE B.V.

Wegalaan 67-69, NL-2132 JD Hoofddorp
The Netherlands
Tel: (31)2356-81-300/Fax: (31)2356-81-388

OMRON ELECTRONICS LLC

1 East Commerce Drive, Schaumburg, IL 60173
U.S.A.
Tel: (1)847-843-7900/Fax: (1)847-843-8568

OMRON ASIA PACIFIC PTE. LTD.

83 Clemenceau Avenue,
#11-01, UE Square,
Singapore 239920
Tel: (65)6835-3011/Fax: (65)6835-2711

Authorized Distributor:

Note: Specifications subject to change without notice.

Cat. No. P053-E1-02
Printed in Japan
0504-2M